



# MAYFIELD® Cranial Stabilization

Systems and Retractor Systems

Product Catalog



<b>Customer Service and Warranty Information</b>	<b>4</b>
<b>MAYFIELD®2 System</b>	<b>6</b>
<b>MAYFIELD® Base Units</b>	<b>8</b>
<b>MAYFIELD® Swivel Adaptors</b>	<b>10</b>
<b>MAYFIELD® Skull Clamps</b>	<b>12</b>
<b>MAYFIELD® Skull Pins</b>	<b>14</b>
<b>MAYFIELD® Horseshoe Headrests</b>	<b>16</b>
<b>MAYFIELD® Infinity Support System</b>	<b>18</b>
<b>MAYFIELD® Infinity Skull Clamp</b>	<b>20</b>
<b>MAYFIELD® Infinity XR2 Radiolucent System</b>	<b>22</b>
<b>MAYFIELD® Infinity XR2 Radiolucent System: Horseshoe Headrests</b>	<b>24</b>
<b>MAYFIELD® Infinity XR2 Radiolucent System: Accessories</b>	<b>25</b>
<b>BUDDE® Halo Retractor System</b>	<b>26</b>
<b>BUDDE® Halo Radiolucent Retractor System</b>	<b>28</b>
<b>Integra® Brain Retractor System</b>	<b>29</b>
<b>Retractor Blades</b>	<b>30</b>
<b>Accessories</b>	<b>32</b>
<b>Indications &amp; Contraindications</b>	<b>36</b>
<b>Index Alphabetical</b>	<b>40</b>
<b>Index Numerical</b>	<b>41</b>

**Integra Limited Warranty**

INTEGRA LIFESCIENCES CORPORATION and its wholly owned subsidiaries ("INTEGRA") warrant to INTEGRA authorized distributors and the original purchaser only that each new Mayfield® product is free from manufacturing defects in material and workmanship under normal use and service for a period of one (1) year (except as otherwise expressly provided as to accessory items and Mayfield® 2) from the date of delivery by INTEGRA (or its authorized distributor) to the original purchaser, but in no event beyond the expiration date stated on any product labeling. For purposes of products sold by INTEGRA through an authorized distributor of INTEGRA, "original purchaser" shall include the purchaser of INTEGRA products to whom the distributor first sells the product.

New Mayfield® 2 products are guaranteed to be free from manufacturing defects in material and workmanship under normal use and service for a period of two (2) years (except as otherwise expressly provided as to accessory items) from the date of delivery by INTEGRA (or its authorized distributor) to the original purchaser, but in no event beyond the expiration date stated on any product labeling. For purposes of products sold by INTEGRA through an authorized distributor of INTEGRA, "original purchaser" shall include the purchaser of INTEGRA products to whom the distributor first sells the product.

- Surgical instruments are guaranteed to be free from defects in material and workmanship when maintained and cleaned properly and used normally for their intended purpose.
- Any covered product that is placed by INTEGRA under a lease, rental or installment purchase agreement and that requires repair service during the term of such placement agreement shall be repaired in accordance with the terms of such agreement.

If any covered defect occurs during the warranty period or term of such placement agreement, the purchaser or distributor should communicate directly with INTEGRA. If purchaser or distributor seeks to invoke the terms of this warranty, the product must be returned to INTEGRA. The defective product should be returned promptly, properly packaged and postage prepaid. Loss or damage in return shipment to INTEGRA shall be at sender's risk. INTEGRA's sole responsibility under this warranty shall be repair or replacement, at INTEGRA's sole discretion at INTEGRA's expense, subject to the terms of this warranty and applicable agreements. IN NO EVENT SHALL INTEGRA BE LIABLE FOR ANY INCIDENTAL, INDIRECT, CONSEQUENTIAL OR PUNITIVE DAMAGES IN CONNECTION WITH THE ACQUISITION OR USE OF ANY INTEGRA PRODUCT. Further, this warranty shall not apply to, and INTEGRA shall not be responsible for, any loss arising in connection with the purchase or use of any INTEGRA product altered in any way so as, in INTEGRA's judgment, to affect its stability or reliability, or which has been subject to misuse, negligence or accident, or which has been used otherwise than in accordance with the instructions furnished by INTEGRA. THIS INTEGRA LIMITED WARRANTY IS EXCLUSIVE AND IN LIEU OF ALL OTHER WARRANTIES, EXPRESS OR IMPLIED, AND OF ALL OTHER OBLIGATIONS OR LIABILITIES ON INTEGRA'S PART OR THE PART OF ITS DISTRIBUTORS, AND INTEGRA NEITHER ASSUMES NOR AUTHORIZES ANY REPRESENTATIVE OR OTHER PERSON TO ASSUME FOR IT ANY OTHER LIABILITY IN CONNECTION WITH INTEGRA'S PRODUCTS.

INTEGRA DISCLAIMS ALL OTHER WARRANTIES, EXPRESS OR IMPLIED INCLUDING ANY IMPLIED WARRANTY OF MERCHANTABILITY OR OF FITNESS FOR A PARTICULAR PURPOSE OR APPLICATION OR WARRANTY OF QUALITY AS WELL AS ANY EXPRESS OR IMPLIED WARRANTY TO PATIENTS. No warranty or guarantee may be created by any act or statement nor may this Standard Warranty be modified in any way, except as a result of a writing signed by an officer of INTEGRA. These limitations on the creation or modification of this warranty may not be waived or modified orally or by any conduct.

IN NO EVENT SHALL INTEGRA AUTHORIZED DISTRIBUTORS BE LIABLE TOWARDS THE ORIGINAL PURCHASER FOR ANY INCIDENTAL, INDIRECT, CONSEQUENTIAL OR PUNITIVE DAMAGES IN CONNECTION WITH THE ACQUISITION OR USE OF ANY INTEGRA PRODUCT. Further, this warranty shall not apply to, and INTEGRA authorized distributors shall not be responsible towards the original purchaser for, any loss, arising in connection with the purchase or use of any INTEGRA product that has been altered in any way so as to affect its stability or reliability, or which has been subject to misuse, negligence or accident, or which has been used otherwise than in accordance with the instructions furnished by INTEGRA. THIS INTEGRA DISTRIBUTOR LIMITED WARRANTY IS EXCLUSIVE AND IN LIEU OF ALL OTHER WARRANTIES TOWARDS THE ORIGINAL PURCHASER, EXPRESS OR IMPLIED, AND OF ALL OTHER OBLIGATIONS OR LIABILITIES TOWARDS THE ORIGINAL PURCHASER ON INTEGRA AUTHORIZED DISTRIBUTOR'S PART.

INTEGRA AUTHORISED DISTRIBUTORS DISCLAIM ALL OTHER WARRANTIES TOWARDS THE ORIGINAL PURCHASER, EXPRESS OR IMPLIED INCLUDING ANY IMPLIED WARRANTY OF MERCHANTABILITY OR OF FITNESS FOR A PARTICULAR PURPOSE OR APPLICATION OR WARRANTY OF QUALITY AS WELL AS ANY EXPRESS OR IMPLIED WARRANTY TO PATIENTS.

**Service and Repair**

For service and repairs outside the United States, contact your local authorized Integra representative.

**Customer Service Contact Information:**

**International**  
+33 (0) 437 47 59 50  
+33 (0) 437 47 59 25 (Fax)  
csemea@integralife.com

**Ireland**  
+353 1800 901567  
+353 1822 5952 (Fax)  
custsvcire@integralife.com

**Austria**  
+43 (0)720816067  
+43 (0)19287201 (Fax)  
custsvcaustria@integralife.com

**Italy**  
+39 (0)2 577 89 21  
+39 (0)2 575 113 71 (Fax)  
custsvcitaly@integralife.com

**Belgium & Luxembourg**  
+32 (0)2 257 4130  
+32 (0)2 253 2466 (Fax)  
custsvcbenelux@integralife.com

**Netherlands**  
+31 (0)852083167  
+31 (0)207093627 (Fax)  
custsvcnetherlands@integralife.com

**France**  
+33 (0) 437 47 59 10  
+33 (0) 437 47 59 29 (Fax)  
custservfrance@integralife.com

**Switzerland**  
+41 (0)2 27 21 23 00  
+41 (0)2 27 21 23 99 (Fax)  
custsvcsuisse@integralife.com

**Germany**  
+49 (0)2102 5535 6200  
+49 (0)2102 5536 636 (Fax)  
custsvcgermany@integralife.com

**United Kingdom**  
+44 (0)1264 312 725  
+44 (0)1264 312 821 (Fax)  
custsvcs.uk@integralife.com



**MAYFIELD® surgical devices**  
**The legacy moves forward**

Developed by neurosurgeon Dr. Frank Mayfield in 1968.



**MAYFIELD® 2 System: Next generation of Cranial Stabilization\***

High performance composite and stainless steel components provide durable, rigid and reliable materials to withstand the requirements of decontamination processes.

**MAYFIELD® Cranial Stabilization Systems and accessories**

More than 40 years of Cranial Stabilization & accessories equipment.



**MAYFIELD® Infinity XR2 Radiolucent System**

Provides versatility in product configurations to meet positioning requirements during intraoperative imaging.

**Brain Retractor Systems**

A broad range of Retractor Solutions for Neurosurgical Procedures.



\* In comparison with our Metal cranial stabilization system.  
Composite material allows rigidity, light weight and withstands high temperature (132-134°(-0/+3°C))

## MAYFIELD® 2 System - NEXT GENERATION of Cranial Stabilization\*

High performance composite and coated stainless steel components provide durable, rigid and reliable materials to withstand the requirements of decontamination processes.

- Autoclave temperatures 132-134°C (-0/+3°C), Time 3 to 18 minutes.
- Wide range of pH detergents (pH from 3 to 11) during manual cleaning process.
- Endures WHO\*\* Protocol for high infectious diseases decontamination.



\*In comparison with our Metal cranial stabilization system.

Composite material allows rigidity, light weight and withstands high temperature 132 to 134°C (-0/+3°C), Time 3 to 18 minutes.

\*\* World Health Organization.



## MAYFIELD® 2 Standard Base Unit

Support device that facilitates attachment of skull clamps and headrests systems to the Operating Room (OR) table.

- No tool required for adjustment.
- New handling as the transitional member is permanently attached to the locking handle.
- Self locking lever to provide added locking mechanism when the system is locked in place.
- Includes A3018 standard swivel adaptor to provide a complete set.

Catalog No. A3101



## MAYFIELD® 2 Skull Clamp

Design based on Modified skull Clamp (A1059) to provide 3-point rigid cranial fixation.

- Only one hand needed to disengage and smoothly slide the ratchet arm.
- Allows precision with skull clamp positioning:
  - > 15 additional rocker arm positions for maximum access to the operative site.
  - > Longer Skull clamp uprights to better interface with Patient's facial Anatomy.
  - > 51% more ratcheting teeth for more precise and smaller increments when pushing together the two halves.
- Compatible with current MAYFIELD® Skull pins

Catalog No. A3059



## MAYFIELD® 2 TriStar Swivel Adaptor

Available for image-guided surgery procedures when ancillary components are required.

Catalog No. A3008

### MAYFIELD® 2\* System:

Components	Catalog #
MAYFIELD® 2 Standard Base Unit**	A3101
MAYFIELD® 2 Skull Clamp	A3059
MAYFIELD® 2 TriStar Adaptor	A3008
MAYFIELD® 2 Standard Swivel Adaptor	A3018

\*All components are sold separately.

\*\*includes A3018 MAYFIELD® 2 Standard Swivel Adaptor

## MAYFIELD® Ultra 360 Patient positioning system

Support/Mounting device that facilitates attachment of MAYFIELD® skull clamps or headrest systems to the Operating Room (OR) table.

- Independent rotating and self-locking handles provide more fluid and flexible movement for better connection to the desired skull clamp position.
- Set-up time is reduced because of the quick handle action.
- More flexible movement with added rotation for additional degrees of freedom.
- Unit can be placed in the reverse position to provide added height.

Catalog No. A2009

System includes:

Component	Catalog #	Quantity
360 Adaptor Assembly	S41A1614	1
360 Tri-Star Adaptor Assembly	S41B1615	1

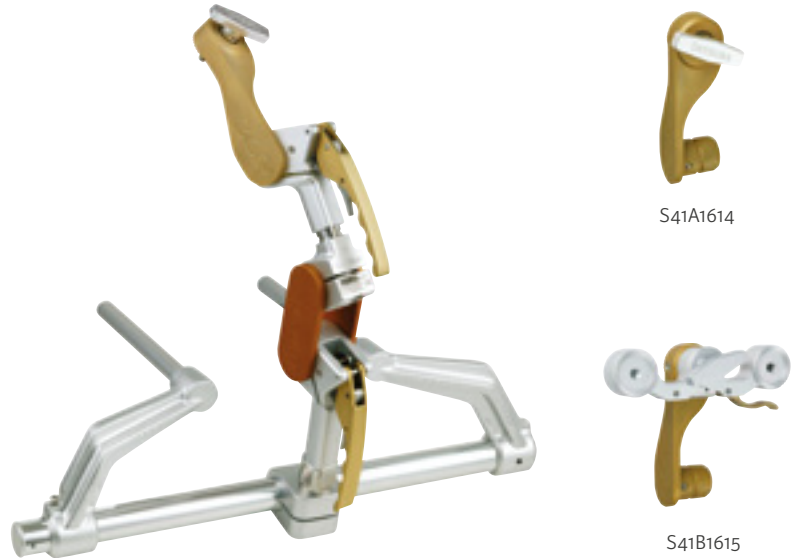

## MAYFIELD® Ultra Base Unit

Support/Mounting device that facilitates attachment of MAYFIELD® skull clamps or headrest systems to the OR table.

- 33%\* more weight and force bearing capacity for improved patient positioning.

Catalog No. A2101



\* Internal testing



## MAYFIELD® Spine Table Adaptor Metal



The spine table adaptor connects MAYFIELD® skull clamps or horseshoe headrests to specialty spine tables.

- Easy attachment to the rails thanks to lock knobs.
- Double-cam locking handle ensures quick and stable fixation.
- Includes the standard transitional member.
- Compatible with metal swivel adaptors, skull clamps and horseshoe headrests.

Catalog No. A2600M

## MAYFIELD® Swivel Adaptor

Adapts headrests and skull clamps to MAYFIELD® base units.

- Provides flexibility in positioning via 360-degree rotation.

Catalog No. A1018



## MAYFIELD® Modified Swivel Adaptor

Same as A1018, with added spring-loaded pin that, when connected to ratchet arm of skull clamp, minimize all movements of the skull clamp components.

- Compatible with all MAYFIELD® skull clamps (except A1114 Infinity skull clamp) and MAYFIELD® horseshoe headrests.

Catalog No. A1115

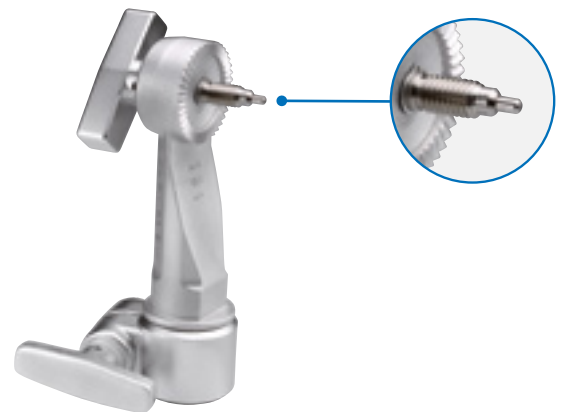

## MAYFIELD® Ball Socket Swivel Adaptor

Attaches to MAYFIELD® base units to provide flexibility in positioning via 360-degree rotation with tilt in any axis.

- Locking pivot permits precise patient positioning.
- Exclusive spring-loaded mechanism provides assured stability.
- Telescoping handle for easy access for tightening and loosening.

Catalog No. A1064



## MAYFIELD® TriStar Swivel Adaptor



Attaches to MAYFIELD® base units to provide flexibility in positioning via 360-degree rotation.

- Provides two additional starbursts to facilitate attachment of ancillary components such as Image Guided Surgery (IGS) dynamic reference frames and articulating arms.
- Starburst can rotate 360-degrees independently of skull clamp to optimize ancillary components positioning.

Catalog No. A2008

## MAYFIELD® Modified TriStar Swivel Adaptor

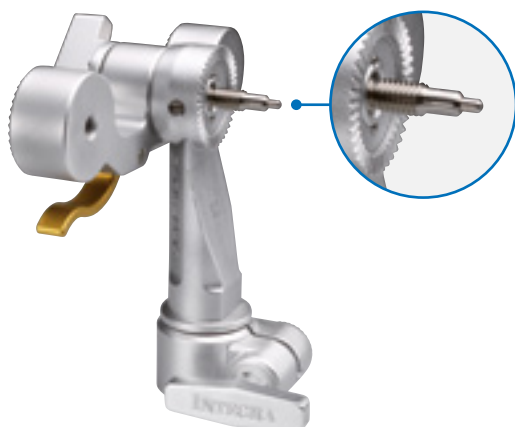

Same as A2008, with added spring-loaded pin that, when connected to ratchet arm of skull clamp, minimize all movements of the skull clamp components.

- Compatible with all MAYFIELD® skull clamps (except the A1114 Infinity skull clamp) and MAYFIELD® horseshoe headrests.

Catalog No. A1116

## MAYFIELD® Modified Skull Clamp

Provides 3-point rigid cranial fixation.

- Flexibility in positioning skull pins around critical areas.
- Quick-release button.

Catalog No. A1059



## MAYFIELD® Triad Skull Clamp

Provides 3-point rigid cranial fixation.

- Provides visual indication of clamping force on ALL THREE skull pins.
- Ability to adjust the force on ALL THREE skull pins with the adjustment wrench.
- Equal impingement of pins ensures firm skull positioning and fixation.

Catalog No. A1108



## MAYFIELD® Infinity Skull Clamp System

Provides 3-point rigid cranial fixation.

- Added length and curved contours of the skull clamp uprights allow clamp to better interface with the horseshoe headrests of the Infinity Support System.
- Multiple rocker arm options: Standard, Triad, Pediatric, Single-pin.
- Adult 80 lb (+/- 36kg) and pediatric 18 lb (+/- 8kg) torque screw options.

Refer p.20-21 for more information

Catalog No. A1114



## MAYFIELD® 2000 Skull Clamp

Provides 3-point rigid cranial fixation.

- Streamlined body design and low profile single pin side facilitates exposure to the operative site.
- Swivel rocker arm mechanism permits flexibility in patient positioning.

Catalog No. A2000









### Reusable Skull Pins

Fit all MAYFIELD® skull clamps to allow rigid cranial fixation.

- Black O-ring connotes a reusable product and allows a good fit in receptacle holes.
- Pediatric skull pins: pinpoint reduced to control penetration.
- Titanium skull pins: designed and tested for use in MR systems up to 3.0 Tesla (T)\*.
- Packaging: supplied individually and non-sterile.

Composition	Adult	Pediatric
Stainless Steel	 Catalog No. A1047	 Catalog No. A1048
Titanium	 Catalog No. A1121	 Catalog No. A1122





\* These skull pins are MR conditional according to terminology specified in the American Society for testing and Materials (ASTM) International. Designation: F2503-05. See product instructions for use for conditions.



## Disposable Skull Pins

Fit all MAYFIELD® skull clamps to allow rigid cranial fixation.

- Red O-ring connotes a disposable product and allows a good fit in receptacle holes.
- Black plastic base connotes a disposable product and body “wings” design improves fitting into receptacle holes of all MAYFIELD® Skull Clamps:
  - Finger grooves molded into the pin body facilitate sure grip and easy removal from pin holders.
- Pediatric skull pins: pinpoint reduced to control penetration.
- Packaging: 36 pins per box (12 sets of 3 sterile pins).
- Titanium disposable skull pins: designed and tested for use in MR systems up to 3.0 Tesla (T)\*.

Composition	Adult	Pediatric
Stainless Steel	 Catalog No. A1083	 Catalog No. A1072
		 Catalog No. A1084
Titanium	 Catalog No. A1120	 Catalog No. A1119



## Radiolucent Disposable Skull Pins

Fit all MAYFIELD® skull clamps to allow rigid cranial fixation.

- Designed and tested for use in MR systems up to 3.0 Tesla (T)\* and engineered from synthetic Sapphire material to limit artifact during CT and MR imaging.
- Packaging: 3 sterile pins per box.

Composition	Adult
Synthetic Sapphire	 Catalog No. A2020

\* These skull pins are MR conditional according to terminology specified in the American Society for Testing and Materials (ASTM F2503-05) International. See product instructions for use for conditions.

## Illustration of a complete MAYFIELD® Headrest System



MAYFIELD® Adult Horseshoe Headrest (A1012) with Ball Socket Swivel Adaptor (A1064) and Ultra Base Unit (A2101).

## MAYFIELD® Adult Horseshoe Headrests

Provide non invasive cranial support in the prone or supine position for adults and older children.

- Vertical and lateral adjustments allow flexibility in patient positioning.
- Supple fluid resistant gel pads provide comfort and reduce the incidence of pressure necrosis.
- Pulley Rod attachment for skeletal traction.
- Needs A1110 MAYFIELD® Triad Horseshoe conversion adaptor with knobs to be attached directly to the transitional member of the MAYFIELD® Ultra Base unit A2101 (see page 34).

Catalog No. A1012

- Same as A1012 except connection is made directly to the transitional member for chin-to-chest positioning.
- Needs A1109 MAYFIELD® horseshoe conversion adaptor to be attached to the MAYFIELD® swivel adaptors or A2009 MAYFIELD® Ultra 360 patient positioning system (see page 34).

Catalog No. A1011



A1012

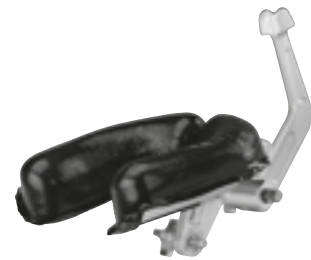

A1011



### MAYFIELD® Pediatric Horseshoe Headrest



Provides non invasive cranial support in the prone or supine position for infants and young children (ages 5+).

- Vertical and lateral adjustments allow flexibility in patient positioning.
- Supple fluid resistant gel pads provide comfort and reduce in the incidence of pressure necrosis.
- Needs A1109 MAYFIELD® horseshoe conversion adaptor to be attached to the MAYFIELD® swivel adaptors or A2009 MAYFIELD® Ultra 360 patient positioning system (see page 34).

Catalog No. A1051

### Papadopoulos Posterior Cervical Spine (PCS) Support



Provides posterior cervical spine support for anterior approaches and easy connection to MAYFIELD® base units.

- Ratcheting system allows easy intraoperative cervical extension.
- Support base is radiolucent to facilitate intraoperative imaging.

Catalog No. A1073

### MAYFIELD® General Purpose Headrest



Provides non invasive cranial support and positioning.

- In supine or semi-sitting procedures
- With gel pads that easily contour the head

Catalog No. A1008

## MAYFIELD® Infinity Support System

Provides multiple cranial support in the prone or supine position for pediatric patients (ages 5+) and adults.

The Infinity system can be attached to any MAYFIELD® base unit, to create a complete head support method (for adult, pediatric or general purpose) with using simultaneously a skull clamp AND a horseshoe headrest. This is especially important for patients who require a low clamping force to stabilize the position of the head, such as pediatric patients (ages 5+) and trauma patients.

The Infinity head supports can be positioned close to the O.R. Table, which is important for patients with short neck lengths.

Catalog No. A1112



Infinity system attached to Ultra Base Unit A2101.

MAYFIELD® Infinity support system (A1112) includes\*:

Components	Catalog #	Quantity
Infinity Support Coupler	S419B1010	1
Horseshoe – Pediatric	S419A1030	1
Horseshoe – Adult	S419A1031	1
Horseshoe – General Purpose	S419A1050	1
Mini Gel Pad for General Purpose	S419A1048	2
Storage Case (not pictured)	S419A1060	1

\* Any of the above components may be ordered separately

Replacement horseshoe headrest gel pads:

Components	Catalog #	Quantity
Pediatric – Left	S440C1011	1
Pediatric – Right	S440C1012	1
Adult – Left	S41C1444	1
Adult – Right	S41C1445	1
Mini gel pad for general purpose	S419A1048	1



Illustration of the Infinity support system mounted on the Ultra Base Unit A2101, the MAYFIELD® swivel adaptor A1018 and the MAYFIELD® Infinity skull clamp A1114.

## MAYFIELD® Infinity Coupler

- No tool needed to mount the coupler to any MAYFIELD® base unit.
- Head supports can be adjusted vertically and laterally for flexibility in patient positioning, then locked in place.
- Position of head support can be tilted on ball socket joint and locked in place.

Catalog No. S419B1010



### MAYFIELD® Infinity Adult Horseshoe



- Provides non invasive cranial support for adults and older children (ages 5+) in either prone or supine positions.
- Adjustable pad base (faceplates) accommodates various head sizes.
- Supple fluid resistant gel pads provide comfort and reduce the incidence of pressure necrosis.
- Easily cleaned.

Catalog No. S419A1031

### MAYFIELD® Infinity Pediatric Horseshoe



- Provides non invasive cranial support for infants and young children in either prone or supine positions.
- Same benefits of the MAYFIELD® Infinity adult horseshoe (S419A1031).

Catalog No. S419A1030

### MAYFIELD® Infinity General Purpose Headrest



- Provides non invasive cranial support in either supine or semi-sitting procedures.
- Mini gel pads can be positioned in multiple receptacles and can be tilted on their hinges.
- Mini gel pads can be used in all MAYFIELD® skull clamp pin carriers for pin less stabilization.
- The use of mini gel pads in MAYFIELD® skull clamp pin carriers must be used in conjunction with a horseshoe headrest thanks to the Infinity support coupler A1112.

Catalog No. S419A1050

## MAYFIELD® Infinity Skull Clamp

Multiple, quick-change, snap-in rocker arm options provide the ability to match the stabilization points to the size of the patient's head for optimal fixation and surgical access. No tools are needed to change rocker arms.

Catalog No. A1114



MAYFIELD® Infinity Skull Clamp System (A1114) includes\*:

Components	Catalog #	Quantity
Infinity Skull Clamp	A1114	1
Adult Rocker Arm	S419B1204	1
Child's Rocker Arm	S419B1205	1
Triad Rocker Arm	S419B1206	1
Single Pin Accessory	S419A1207	1
Reduced Load 18-lb (+/- 8kg) torque screw	S419A1208	1
80-lb (+/- 36kg) Torque Screw	S419A1209	1
Adjustment Wrench	S41A1482	1
Storage Case (not pictured)	S419A1250	1

Infinity Skull Clamp shown with:

- 80-lb (36kg) Torque Screw S419A1209
- Standard Adult Rocker Arm S419B1204
- Infinity Support System A1112
- MAYFIELD® Ultra Base Unit A2101
- MAYFIELD® Tri-Star Swivel Adaptor A2008
- MAYFIELD® Adult disposable skull pins A1072

\*Any of the above components may be ordered separately.

## MAYFIELD® Torque Screw

Two torque Screw options to assist in providing the desired amount of pressure for the patient and the procedure.

- Standard MAYFIELD® 80 lbs (+/- 36kg) Torque Screw
- Reduced load 18 lbs (+/- 8kg) Torque Screw provided for procedures where lower, more controlled pressure and less penetration of the pins is needed.

NOTE: The reduced load torque screw should always be used in conjunction with a horseshoe headrest or other form of primary patient head support.



80 lb (+/-36kg) Torque Screw  
Catalog No. S419A1209



18 lb (+/-8kg) Torque Screw  
Catalog No. S419A1208

## Rocker Arm options



### MAYFIELD® Triad Rocker Arm

- Provides visual indication of clamping force of the two pins on the rocker arm.
- Ability to adjust clamping force on each pin thanks to the adjustment wrench .

Catalog No. S419B1206

---

### MAYFIELD® Standard Adult Rocker Arm



The same two-pin rocker arm provided with the standard MAYFIELD® skull clamp.

Catalog No. S419B1204

---

### MAYFIELD® Child's Rocker Arm



Rocker Arm configured for smaller patient skull's size.

Catalog No. S419B1205

---

### MAYFIELD® Single Pin Accessory



Provides a direct opposing point of stabilization with the Torque Screw pin. Flexibility in positioning of pins around critical areas and the surgical site.

Catalog No. S419A1207

## MAYFIELD® Infinity XR2 Radiolucent System

- Provides versatility in product configurations to meet positioning requirements during intraoperative imaging.



Products shown:  
 - MAYFIELD® XR2 Skull Clamp A2114  
 - MAYFIELD® XR2 Base Unit A2079; including MAYFIELD® XR2 Swivel Adaptor (439A1094)

## MAYFIELD® Infinity XR2 Base Units

Provide rigid support between surgical table and skull clamp or headrest for patient positioning\*.

- Suitable for Digital Subtraction Angiography (DSA), Fluoroscopy and CT imaging modalities\*.
- Set-up and positioning is easy with the simplified linkage components that are secured by colorcoded dual-action knobs, saving operating time.
- Double-cam locking handles for easier opening.
- No tool is required for adjustment of the locking handle tension.
- Horizontal bar provides a wide imaging window - full side-to-side lateral positioning.
- Incompatible with MAYFIELD® Standard systems

Catalog No. A2079 or No. A2079E



Components	A2079	A2079E (Extended)
Total width	28.35 In (72cm)	32.45 In (82,4 cm)
Rail to rail width	19.5 In to 24 In (49,6 cm to 61 cm)	22 In to 28 In (55,9 cm to 71,1 cm)
Rail channel	1.26 in (3,2 cm)	
Standard rad. Swivel Adaptor included	Yes	

\* Refer to A2079/A2079E IFU - publication number 451A2079 Rev C

## MAYFIELD® Radiolucent Spine Table Adaptor



The Spine Table Adaptor connects A2114 MAYFIELD® skull clamp.

- Easy attachment to the rails thanks to lock knobs.
- Double-cam locking handle allows quick and secure fixation.
- Connects to standard rail brackets of spine tables.

Catalog No. A2600R

## MAYFIELD® Infinity XR2 Skull Clamp



Provides rigid 3-point skeletal fixation for cranial and cervical procedures involving Digital Subtraction Angiography (DSA), fluoroscopy, CT imaging, and MR imaging modalities.

- MR compatible up to 3 Tesla with standard version.
- Optional : using metal-free torque screw will avoid image distortion or artefact.

- 80-lbs torque knob on the single-pin side for a familiar position & easy to read.
- Double-pawl ratchet mechanism for easier application of the skull clamp by the surgeon to the patient.
- Easy assembly and disassembly of the Rocker arms: no tool is needed.
- Includes the adult Rocker arm 439A1094.

Catalog No. A2114

## Removable Rocker Arm



- No tool is needed to remove the Rocker Arm for cleaning or changing to another size.
- Tapered shaft hold the Rocker Arm in place.

Catalog No. 439A1094

## MAYFIELD® Adult Radiolucent Horseshoe Headrest

- Provides non invasive support in the prone and supine position during diagnostic examination or surgical procedures.
- Offers the same benefits of the standard horseshoe headrest (A1012).
- Composite carbon fiber provides strength, durability and minimal artifact during imaging.
- Designed to be used with the MAYFIELD® Radiolucent Base Units A2079, A2079E and A2600R.

Catalog No. A2010



---

## MAYFIELD® Pediatric Radiolucent Horseshoe Headrest

- Provides non invasive support in the prone and supine position for children during diagnostic examination or surgical procedures
- Offers the same benefits of the adult radiolucent horseshoe headrest.

Catalog No. A2011





## Portable CT Set-Up with Link Arm Extensions

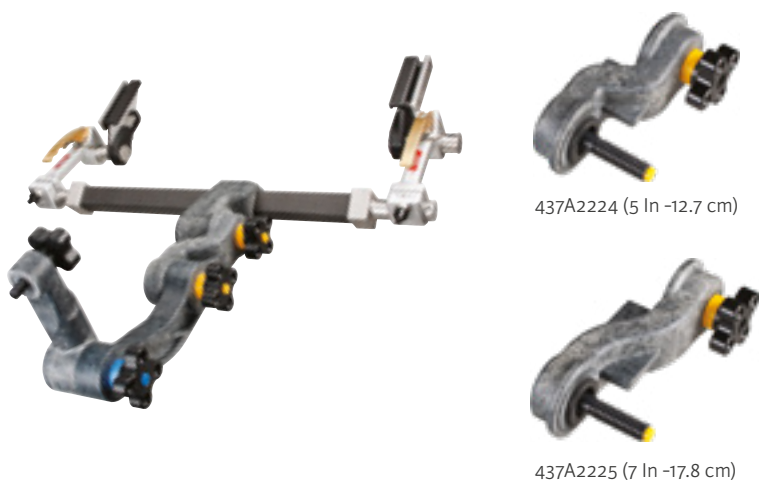

- Provide additional length to allow non-Radiolucent components of the XR2 Base Unit to be positioned further outside the imaging window.

Catalog No. 437A2224 (5 In -12.7 cm) Link Arm Extension  
Catalog No. 437A2225 (7 In -17.8 cm) Link Arm Extension

## Force Module & Metal-Free Conversion Accessory



Metal-Free Conversion Accessory  
(439A1092)



Removable Force Module  
(439A1093)

- Converts the skull clamp to be free of any metal in the product during imaging.

Catalog No. 439A1092  
Catalog No. 439A1093

## Removable Child Rocker Arm



- Rocker Arm holds two skull pins, allows for positioning on smaller skull sizes.

Catalog No. 439A1091

## MAYFIELD® Infinity XR2 Tri-Star Swivel Adaptor



Designed to provide flexibility in positioning patient's head by allowing rotation in 360 degrees.

- Provides two extra starburst attachments for ancillary equipment, when needed.
- Allows for a strong attachment of image guided surgery components.
- Easy set-up and firm fixation onto the base unit and the skull clamp thanks to standard fixation screws.

Catalog No. A2111

## BUDDE® Halo Retractor System

Attaches to MAYFIELD® Skull Clamps or to the side rails of the OR table to provide a sturdy platform for retraction or hand rest for the surgeon.

- Double-Hinged ContinuTrac™ halo ring provides 360-degrees of uninterrupted retractor arm placement for flexibility.
- Low profile design allows for ease of instrument passage within the surgical field.
- Ideal for posterior fossa procedures.
- Blades can be micro-manipulated without flex arm extension readjustment.
- Budde® Halo Side Rail Support (A1067) and MAYFIELD® Universal Side Rail Fitting (A1060) allows fixation of the system to the OR table when a conventional skull clamp is not used.
- Sterilizable.

Catalog No. A1040



Shown on a MAYFIELD® Triad Skull Clamp (A1108, see on page 11) and A2008 MAYFIELD® Tri-Star Adaptor Modified (seen on page 11).

BUDDE® Halo Retractor System (A1040) includes:

Components	Catalog #	Quantity
ContinuTrac™ Halo Ring	S438B1178	1 each
9" (229 mm) Halo Flex Arm	S438A1011	3 each
BUDDE® Halo Support Bracket	S438B1010	2 each
BUDDE® Halo Support Rod (5/16")	S438A1188	2 each
BUDDE® Halo Pattie Tray	S438A1037	1 each
Halo Mini Vise (not shown)	S438A1140	1 each
BUDDE® Curved Retractor Blades - SS (Stainless Steel)*	438A1077 A,B,C,D,X	2 each
TEW™ Micro Retractor Blades - SS (not shown)*	438A1082 A,B,C	1 each
TEW™ Micro Retractor Blades - SS (not shown)*	438A1083 A,B,C	1 each
SAMY Vascular Retractors, short - SS (not shown)*	438A1200A	Set of 3
SAMY Vascular Retractors, long - SS (not shown)*	438A1200B	Set of 3
Halo Adjustment Wrench (not shown)	S438A1024	2 each
Halo Poly Vac Sterilization Case (not shown)	S438A1096	1 each

Optional Accessories:

Components	Catalog #
BUDDE® Halo Side Rail Support	A1067
TEW™ Hooked Micro Retractor Blades (2mm) - SS*	438A1151 A,B,C,D
TEW™ Hooked Micro Retractor Blades (4mm) - SS*	438A1152 A,B,C,D
Budde® Tapered Retractor Blades - SS*	438A1154 B,C,D,E
TEW™ Serrated Micro Retractor Blades (2mm) - SS*	438A1155 A,B,C,D
TEW™ Serrated Micro Retractor Blades (4mm) - SS*	438A1157 A,B,C,D
12" (300mm) Halo Flex Arm	S438A1012

\* Refer p. 30 for size information

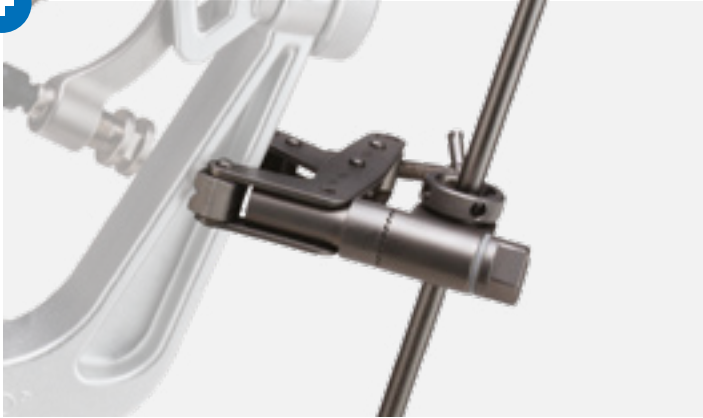

**Attachment onto the Skull Clamp**

The Support Bracket allows attachment directly onto the Skull Clamp.

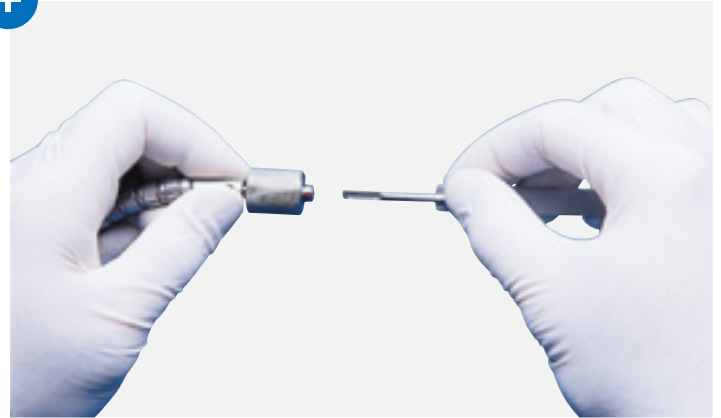

**Low Profile Click-in Blade**

Low profile click-in blades eliminate obstruction of the surgical site.

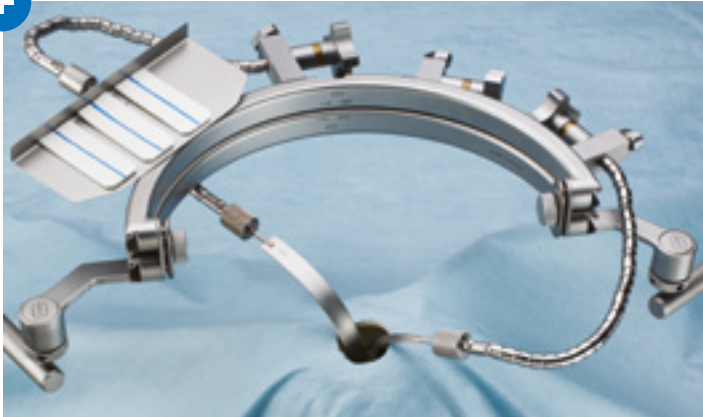

**Half Ring**

Double hinged design allows the halo ring to be easily angled for multiple approaches to the surgical field.



**ContinuTrac™ Halo Ring**

Double-Hinged ContinuTrac™ Halo Ring provides 360-degrees of uninterrupted retractor arm placement for more flexibility.



**Side Rail Support**

Recommended for surgical procedures when a conventional skull clamp is not used.

## BUDDE® Halo Radiolucent Retractor System



BUdde® Halo Radiolucent A1096 shown on a XR2 Infinity Skull Clamp A2114.

Attaches to MAYFIELD® radiolucent skull clamps. Provides a sturdy platform for retraction and a ready support or hand rest for the surgeon.

- Radiolucent components allow the system to remain in place during intraoperative imaging.
- Compatible with the MAYFIELD® Radiolucent Headrest System (A2114).
- Imaging compatible titanium retractor arms can remain in place during scanning.
- Ring can be quickly changed to a half ring set-up for improved access thanks to the hinge.
- Blades can be micro-manipulated without flex arm extension readjustment.
- Designed to significantly reduce or limit artefact during intracranial procedures.

Catalog No. A1096

BUdde® Halo Radiolucent Retractor System (A1096) includes:

Components	Catalog #	Quantity
Halo Ring	S443A1000	1 each
9" (229mm) Halo Flex Arm – TI (titanium)	S443A1070A	3 each
Rod Support Clamp Assembly	S443A1060	2 each
Radiolucent Support Rod	S443B1052	2 each
Halo Pattie Tray – SS (stainless steel)	S438A1037	1 each
Halo Mini Vise – SS (not shown)	S438A1140	1 each
Halo Adjustment Wrench (not shown)	S443A1004	1 each
Halo Poly Vac Sterilization Case (not shown)	S443A1005	1 each
BUdde® Curved Retractor Blades – SS*	438A1077A,B,C,D,X	2 each
TEW™ Micro Retractor Blades – SS (not shown)*	438A1082A,B,C	1 each
TEW™ Micro Retractor Blades – SS (not shown)*	438A1083A,B,C	1 each
SAMY Vascular Retractors, short – SS (not shown)*	438A1200A	Set of 3
SAMY Vascular Retractors, long – SS (not shown)*	438A1200B	Set of 3

Optional Accessories:

Components	Catalog #
TEW™ Hooked Micro Retractor Blades (2mm) – SS*	438A1151 A,B,C,D
TEW™ Hooked Micro Retractor Blades (4mm) – SS*	438A1152 A,B,C,D
Budde Tapered Retractor Blades – SS*	438A1154 B,C,D,E
TEW™ Serrated Micro Retractor Blades (2mm) – SS*	438A1155 A,B,C,D
TEW™ Serrated Micro Retractor Blades (2mm) – SS*	438A1157 A,B,C,D
12" (300mm) Halo Flex Arm – TI	S443A1070B
6" (150mm) Halo Flex Arm – TI	S443A1070C

\* Refer p. 30 for size information

## Integra Brain Retractor system



A complete system with individual components providing as much or as little retraction as needed for each procedure.

- Modular, self-retaining components allow a variety of configurations to surround the surgical site for retraction.
- Compatible with all MAYFIELD® skull clamps and can be brought at any stage during the procedure.
- The system can be attached to the skull clamp or directly to the operating room table for procedures where a skull clamp is not necessary.
- Sterilizable.

Catalog No. A2012

## Multiple Configurations



One retractor arm with one retractor blade



Two retractor arms with two retractor blades



Side rail attachment with one retractor arm and one retractor blade

Integra Brain Retractor System (A2012) includes\*:

Components	Catalog #	Quantity
Primary bars and clamp assembly	417A1000	2 each
Floating Secondary Bars	417A1001	4 each
Retractor Arms 9.5"	417A1002	4 each
Handrest	417A1003	1 each
PATTIE Tray	417A1004	1 each
Tapered Retractor Blade, 1/4" to 3/4"(6.4 mm to 19.1 mm)**	417A1005	1 each
Tapered Retractor Blade, 5/32" to 5/8"(4.0 mm to 15.9mm)**	417A1006	1 each
Tapered Retractor Blade, 1/8" to 1/2"(3.2 mm to 12.7 mm)**	417A1007	1 each
Tapered Retractor Blade, 3/32" to 3/8"(2.4 mm to 9.5 mm)**	417A1008	1 each
Tapered Retractor Blade, 1/16" to 1/4"(1.6 mm to 6.4 mm)**	417A1009	1 each
Sterilization Case (not shown)	417A1010	1 each

\* any of the above components may be ordered separately.

\*\* Refer p. 30 for size information

## Brain Retractor-Blade Table

The table below shows retractor-blade usability. (•) indicates that the retractor will hold the blade, (x) indicates that an additional device, Mini Vise (S438A1140) is required

Reference	Size in inch (Width x Length) unless otherwise noted	Size in mm (Width x Length) unless otherwise noted	A1040 Budde® Halo	A1096 Budde® Halo Radiolucent	A2012 Integra Brain Retractor System
<b>Tapered Retractor Blades - Taper x 9" (229mm)</b>					
417A1005	1/4" to 3/4"	6.4mm to 19.1mm	X	X	•
417A1006	5/32" to 5/8"	3.9mm to 15.9mm	X	X	•
417A1007	1/8" to 1/2"	3.2mm to 12.7mm	X	X	•
417A1008	3/32" to 3/8"	2.4mm to 9.5mm	X	X	•
417A1009	1/16" to 1/4"	1.6mm to 6.4mm	X	X	•
<b>Budde® Curved Retractor Blades</b>					
438A1077A	1/4" x 4"	6.3mm x 102mm	•	•	•
438A1077B	3/8" x 4"	9.5mm x 102mm	•	•	•
438A1077C	5/8" x 4"	15.9mm x 102mm	•	•	•
S438A1077D	3/4" x 4"	19.1mm x 102mm	•	•	•
438A1077E*	1" x 4"	25.4mm x 102mm	•	•	•
438A1077X	1/2" x 4"	12.7mm x 102mm	•	•	•
<b>Budde® Tapered Retractor Blades</b>					
438A1154B*	3/8" Min. width x 4"	9.5mm Min. Width x 102mm	•	•	•
438A1154C*	5/8" Min. width x 4"	15.9mm Min. width x 102mm	•	•	•
438A1154D*	3/4" Min. width x 4"	19.1mm Min. width x 102mm	•	•	•
438A1154E*	1" Min. width x 4"	25.4mm Min. width x 102mm	•	•	•
<b>Budde® TEW™ Micro Retractor Blades</b>					
438A1082A	0.07" x 4.5"	2mm x 114mm	•	•	•
438A1082B	0.07" x 5.5"	2mm x 140mm	•	•	•
438A1082C	0.07" x 6.5"	2mm x 165mm	•	•	•
438A1082D*	0.07" x 7.5"	2mm x 191mm	•	•	•
438A1083A	0.15" x 4.5"	4mm x 114mm	•	•	•
438A1083B	0.15" x 5.5"	4mm x 140mm	•	•	•
438A1083C	0.15" x 6.5"	4mm x 165mm	•	•	•
438A1083D*	0.15" x 7.5"	4mm x 191mm	•	•	•

\* Retractor not included in Budde® Halo Retractor System (A1040 & A1096)

Reference	Size in inch (Width x Length) unless otherwise noted	Size in mm (Width x Length) unless otherwise noted	A1040 Budde® Halo	A1096 Budde® Halo Radiolucent	A2012 Integra Brain Retractor System
<b>Budde® TEW™ Micro, Hooked Retractor Blades</b>					
438A1151A*	0.07" x 4.5"	2mm x 114mm	•	•	•
438A1151B*	0.07" x 5.5"	2mm x 140mm	•	•	•
438A1151C*	0.07" x 6.5"	2mm x 165mm	•	•	•
438A1151D*	0.07" x 7.5"	2mm x 191mm	•	•	•
438A1152A*	0.15" x 4.5"	4mm x 114mm	•	•	•
438A1152B*	0.15" x 5.5"	4mm x 140mm	•	•	•
438A1152C*	0.15" x 6.5"	4mm x 165mm	•	•	•
438A1152D*	0.15" x 7.5"	4mm x 191mm	•	•	•
<b>TEW™ Micro, Serrated Retractor Blades</b>					
438A1155A*	0.07" x 4.5"	2mm x 114mm	•	•	•
438A1155B*	0.07" x 5.5"	2mm x 140mm	•	•	•
438A1155C*	0.07" x 6.5"	2mm x 165mm	•	•	•
438A1155D*	0.07" x 7.5"	2mm x 191mm	•	•	•
438A1157A*	0.15" x 4.5"	4mm x 114mm	•	•	•
438A1157B*	0.15" x 5.5"	4mm x 140mm	•	•	•
438A1157C*	0.15" x 6.5"	4mm x 165mm	•	•	•
438A1157D*	0.15" x 7.5"	4mm x 191mm	•	•	•
<b>SAMY Vascular Retractor Blades - Diameters 0,12"; 0,19" &amp; 0,27" (set of 3) / Diameters - 3, 5 &amp; 7mm (set of 3)</b>					
438A1200A	Short - 3.6" Length	Short - 91.4mm Length	•	•	•
438A1200B	Long - 4.6" Length	Long - 117mm Length	•	•	•

\* Retractor not included in Budde® Halo Retractor System (A1040 & A1096)

## MAYFIELD® NeuroGen Adaptor

Support/Mounting device that allows attachment of base units to the OR table when receptacle holes are absent or inappropriate.

- Quick adjustable end bracket to fit a wide range of table widths; from 21,375" (54,29 cm) to (62,230 cm).
- Easy attachment to OR table side rails thanks to lock knobs.
- Provides optional lateral adjustment with multiple mounting holes for base unit placement.

Catalog No. A1113



## MAYFIELD® Crossbar Adaptor

For seated position procedures:

- Easily mounts to OR table side rails to adapt all MAYFIELD® Skull Clamps for posterior fossa craniotomy procedures or posterior cervical laminectomies.
- Allows for unobstructed view of the posterior cervical spine and occipital areas.
- Compatible with most currently available OR tables.
- Requires use of 2 A1060 Side Rail Fittings.

Catalog No. A1015





## MAYFIELD® Universal Side Rail Fitting

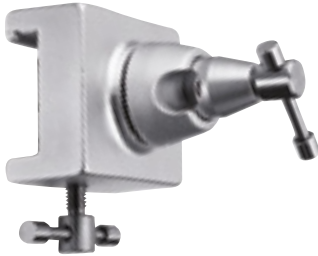

- For attaching the MAYFIELD® Crossbar Adaptor (A1015) and other products to the OR table.
  - Compatible with most currently available OR tables.
- Catalog No. A1060

## INTEGRA™ Cranial Stabilisation Covers



Non-Sterile, Disposable Covers designed to protect MAYFIELD® Systems.

- Reduce cleaning time.
- Protect critical components.

Catalog No. A1118

## MAYFIELD® Instrument Wall Storage Unit



Wall board used to organize and store MAYFIELD® products.

- Printed instrumental silhouettes make proper storage quick and easy.
- Holds all MAYFIELD® Headrest components.
- Delivered empty.

Catalog No. A1023

## MAYFIELD® horseshoe conversion adaptor

Allows an A1011 MAYFIELD® horseshoe headrest and A1051 MAYFIELD® paediatric horseshoe headrest to attach to A1018, A1064, A2008 and adaptor assembly of the A2009 MAYFIELD® Ultra 360™ Patient positioning system.

Catalog No. A1109



---

## MAYFIELD® Triad horseshoe conversion adaptor with knobs

Allows an A1012 MAYFIELD® horseshoe headrest to attach to standard transition members.

- Provides a means of obtaining chin-to-chest positioning.

Catalog No. A1110



---

## BUDDE® Halo Side Rail Support

Allows the BUDDE® Halo retractor system to attach directly to the operating table.

Catalog No. A1067





**MAYFIELD® Base Units (A2101, A2009, A3101)**

Indications: MAYFIELD® Base Units are designed for patient positioning in the prone, supine, and sitting positions.

Contraindications: Do not use for other indications than the ones specified in the instructions for use.

**MAYFIELD® Base Units (A2079, A2079E)**

Indications: The Infinity XR2 Base Unit is intended to be used to support a patient during diagnostic examination and/or surgical procedures where a rigid support between surgical table and headrest, or skull clamp is necessary, positional freedom is required and where X-ray imaging modalities will be used.

Contraindications: Do not use for other indications than the ones specified in the instructions for use.

**MAYFIELD® Spine Table Adaptors (A2600M, A2600R)**

Indications: The MAYFIELD® Spine Table Adaptor is intended to be used to support a patient during diagnostic examination and/or surgical procedures where a rigid support between the carbon composite parallel rails style of surgery table and the skull clamp or headrest is necessary and positional freedom is required. (Item number A2600R is indicated for use when X-ray imaging modalities are required)

Contraindications: Do not use for other indications than the ones specified in the instructions for use.

**MAYFIELD® Swivel Adaptors (A1018, A1115, A1064, A2008, A1116, A3018, A3008)**

Indications: MAYFIELD® Swivel Adaptors are designed to provide greater flexibility in positioning the patient's head by allowing rotation in 360 degrees.

Contraindications: Do not use for other indications than the ones specified in the instructions for use.

**MAYFIELD® Skull Clamps (A1114, A1108, A1059, A2000, A3059, A2114)**

Indications: MAYFIELD® Skull Clamps are designed to give rigid skeletal fixation and allow the surgeon more freedom in positioning the fixation pins.

Contraindications: Do not use for other indications than the ones specified in the instructions for use.

**MAYFIELD® Adult and Pediatric Reusable skull pins (steel) (A1047, A1048)**

Indications: The MAYFIELD Reusable Adult (REF A1047) and Child (REF A1048) Skull Pins are used in conjunction with all generations of MAYFIELD brand Skull Clamps (REF A1013, A1014, A1059, A1108, or A2000), MAYFIELD brand Radiolucent Skull Clamps (REF A1058 or A2002), and the Improved GARDNER brand Skull Clamp (REF A1035) when rigid skeletal fixation is required. These pins are made of stainless steel and are removable for sterilization and reuse.

Contraindications: Do not use for other indications than the ones specified in the instructions for use.

**MAYFIELD® Adult and Pediatric Disposable skull pins (steel) (A1083, A1084, A1072)**

Indications: The MAYFIELD® Disposable Skull Pins, Adult- Plastic Base (REF A1072), Adult- Stainless Steel (REF A1083), or Child Stainless Steel (REF A1084) are used in conjunction with all generations of MAYFIELD brand Skull Clamps (REF A1013, A1014, A1059, A1108, or A2000), MAYFIELD brand Radiolucent Skull Clamps (REF A1058 or A2002), and the Improved GARDNER brand Skull Clamp (REF A1035) when rigid skeletal fixation is required.

Contraindications: Do not use for other indications than the ones specified in the instructions for use.

**MAYFIELD® Adult Reusable Radiolucent skull pin (A2020)**

Indications: The MAYFIELD® Radiolucent Skull pins (REF A2020) are intended for use with a skull clamp that is placed on the patient's skull to hold the head and neck in a particular position during surgical procedures where rigid skeletal fixation is desired and intra-operative CT or MR imaging is used.

Contraindications: Do not use for other indications than the ones specified in the instructions for use.

**MAYFIELD® Adult and Pediatric Reusable skull pins (Titanium) (A1121, A1122)**

Indications: The MAYFIELD Reusable Titanium Skull Pins (REF A1121, A 1122) are intended for use with a MAYFIELD skull clamp that is placed on the patient's skull to hold their head and neck in a particular position during surgical procedures where rigid skeletal fixation is desired and intra-operative MR imaging is used. The MAYFIELD Reusable Titanium Skull Pins (REF A1121, A1122) are indicated for use in open and percutaneous craniotomies and spinal surgeries when rigid skeletal fixation is necessary and when intra-operative MR imaging of the patient is used.

Contraindications: Do not use for other indications than the ones specified in the instructions for use.

**MAYFIELD® Adult and Pediatric Disposable skull pins (Titanium) (A1120, A1119)**

Indications: The MAYFIELD® Disposable Titanium Skull Pins (REF A1119 and A1120) are intended for use with a MAYFIELD® skull clamp that is placed on the patient's skull to hold their head and neck in a particular position during surgical procedures where rigid skeletal fixation is desired and intra-operative MR imaging is used.

Contraindications: Do not use for other indications than the ones specified in the instructions for use.

**MAYFIELD® Adult and Pediatric Horseshoe Headrests (A1012, A1011, A1051, A2010, A2011)**

Indications: MAYFIELD Swivel Horseshoe Headrests are designed for the prone and supine positions.

Contraindications: Do not use for other indications than the ones specified in the instructions for use.

**Papadopoulos Posterior Cervical Spine (PCS) Support (A1073)**

Indications: The Papadopoulos Posterior Cervical Spine (P.C.S.) Support (REF A1073) is designed for anterior cervical spine surgery and instrumentation. The instrument supports the cervical spine in an anatomic position and allows easy access for the surgeon and radiologic imaging equipment. The P.C.S. Support is made of a radiolucent material and is adjustable in three planes: anterior-posterior, rostral-caudal, and medial-lateral.

Contraindications: Do not use for other indications than the ones specified in the instructions for use.

**MAYFIELD® General Purpose Headrest (A1008)**

Indications: The MAYFIELD General Purpose Headrest (REF A1008) is designed for the supine or semi-sitting positions. The MAYFIELD Ultra Base Unit (REF A2101) with its Transitional Member and either the MAYFIELD Ball Socket Swivel Adapter (REF A1064), the MAYFIELD Swivel Adapter (REF A1018), or the MAYFIELD Tri-Star Adapter (REF A2008) are required when using the MAYFIELD General Purpose Headrest. This system permits support of the head when rigid skeletal fixation is not needed.

Contraindications: Do not use for other indications than the ones specified in the instructions for use.

**MAYFIELD® Infinity Support System (A1112)**

Indications: The MAYFIELD Infinity Support System is a headrest support device that attaches to any MAYFIELD Base Unit Support Rods (A2101 or older models), creating a method for simultaneous application of a Headrest (adult, pediatric, or general purpose) and a Skull Clamp (ages 5+).

Contraindications: Do not use for other indications than the ones specified in the instructions for use.

**BUDDE® Halo Retractor System (A1040)**

**Indications:** The BUDDE® Halo Neurosurgical Retractor System (REF A1040) was designed for use in all intercranial procedures where retraction of delicate brain tissue is required. The BUDDE Halo Retractor is used in conjunction with the MAYFIELD Skull Clamps (REF A1013, A1014, A1059, A1108 & A2000) or the MAYFIELD Radiolucent Skull Clamps (REF A1058 & A2002). The BUDDE Halo Retractor attaches to the skull clamp after the sterile draping process has been completed. For those intercranial procedures in which a conventional skull clamp is not employed (i.e. pediatric brain surgery), the BUDDE Halo Retractor is used in conjunction with the BUDDE Halo Side Rail Support (REF A1067) to secure the system to the side rails of the operating room table.

**Contraindications:** Do not use for other indications than the ones specified in the instructions for use.

**Integra Brain retractor system (A2012)**

**Indications:** The Integra Brain Retractor System is indicated for retraction of brain tissue during neurosurgical procedures. The Integra Brain Retractor may be used in conjunction with MAYFIELD Skull Clamps (REF A1013, A1014, A1059, A1108, A1114, and A2000) or may attach to the side rails of the operating room table. The Integra Brain Retractor System also serves to support and position various instruments and handrests.

**Contraindications:** Do not use for other indications than the ones specified in the instructions for use.

**BUDDE® Halo Radiolucent Retractor System (A1096)**

**Indications:** The BUDDE Halo Radiolucent Retractor System (REF A1096) is designed to reduce or limit artifact during intracranial procedures where retraction of delicate brain tissue is required. The BUDDE Halo Radiolucent Retractor is used in conjunction with the MAYFIELD Skull Clamp (typically the MAYFIELD Radiolucent Skull Clamp REF A2002). The BUDDE Halo Radiolucent Retractor attaches to the skull clamp after the sterile draping process is complete.

**Contraindications:** Do not use for other indications than the ones specified in the instruction for use.

**MAYFIELD® NeuroGen Adaptor (A1113)**

**Indications:** The MAYFIELD NeuroGen Adaptor (REF A1113) is designed for use as an adaptor to mount the MAYFIELD Base Unit to the operating table when the table's receptacle holes are not appropriate or present. An adjustable end bracket allows the NeuroGen Adaptor to fit a wide variety of operating room tables. The NeuroGen can also be stored directly to the operating room table without interfering with other surgical procedures.

**Contraindications:** Do not use for other indications than the ones specified in the instructions for use.

**MAYFIELD® Crossbar Adaptor (A1015)**

**Indications:** The MAYFIELD Crossbar Adaptor (REF A1015 & A1016) is designed for procedures requiring sitting positions, primarily the posterior fossa craniotomy and the posterior cervical laminectomy when performed in the sitting position.

**Contraindications:** Do not use for other indications than the ones specified in the instructions for use.

**MAYFIELD® Universal Side Rail Fitting (A1060)**

**Indications:** The MAYFIELD Universal Side Rail Fitting (REF A1060) is designed for the attachment of the MAYFIELD Crossbar Adaptor (REF A1015 or A1016), Garreston Overhead Instrument Table (REF A1053), and the BUDDE Halo Retractor Side Rail Support (REF A1067) to the side rails of the operating room table when the table's rail fittings are not appropriate or present.

**Contraindications:** Do not use for other indications than the ones specified in the instructions for use.

**INTEGRA™ Cranial Stabilisation Covers (A1118)**

**Indications:** Integra® Cranial Stabilization Covers are used to cover MAYFIELD® base units, swivel adapters, and skull clamps. The Covers are used to protect the equipment from contamination during surgical procedures.

**Contraindications:** Do not use for other indications than the ones specified in the instructions for use.

**MAYFIELD® Instrument Wall Storage Unit (A1023)**

**Indications:** The MAYFIELD Wall Storage Unit (REF A1023) is designed for the storage of the complete MAYFIELD Neurosurgical Headrest System. Each instrument silhouette is printed on the board to ensure easy and proper storage. Each MAYFIELD Headrest component is placed on a specific custom-made holding bracket.

**Contraindications:** Do not use for other indications than the ones specified in the instructions for use.

**MAYFIELD® Horseshoe Conversion Adaptor (A1109)****MAYFIELD® Triad Horseshoe Conversion Adaptor with Knobs (A1110)**

**Indications:** The Mayfield Horseshoe Conversion Adaptors (REF A1109, A1110) were designed to allow for the attachment of the Horseshoe Headrest (REF A1011) to attach to Mayfield Swivel adapters (REF A1018, A1064, or A2008). Also, the Horseshoe Conversion Adapter with knobs (REF A1110) allows for the attachment of Horseshoe Headrest (REF A1012) to attach directly to the standard 6" transitional member (REF S41B1171).

**Contraindications:** Do not use for other indications than the ones specified in the instructions for use.

**BUDDE® Halo Side Rail Support (A1067)**

**Indications:** The BUDDE® Halo Retractor Side Rail Support (REF A1067) is designed for the adaptation and attachment of the BUDDE® Halo Brain Retractor System (REF A1040) to the operating room table when a conventional skull clamp is not employed. The Side Rail Support allows for the BUDDE® Halo Brain Retractor to be used for pediatric brain surgery of all types and the ontological surgical approach to acoustic neuromas. BUDDE® Halo Retractor Side Rail Support is used in conjunction with the MAYFIELD® Universal Side Rail Fittings (REF A1060) to securely attach the BUDDE® Halo Brain Retractor to the side rails of the operating room table.

**Contraindications:** Do not use for other indications than the ones specified in the instructions for use.





**Products**  
**References**

**A**

Adult Disposable Skull Pins.....	15
Adult Horseshoe Headrests .....	16
Adult Radiolucent Disposable Skull Pins .....	15
Adult Radiolucent Horseshoe Headrest.....	24
Adult Reusable Skull Pins .....	14

**B**

Ball Socket Swivel Adaptor.....	10
Brain Retractor-Blade.....	30
BUDDE® Halo Radiolucent Retractor System .....	29
BUDDE® Halo Retractor System .....	26
BUDDE® Halo Side Rail Support.....	26, 34

**C**

Child's Rocker Arm .....	21
Cranial Stabilisation Covers .....	33
Crossbar Adaptor.....	32

**F**

Force Module & Metal-free Conversion Accessory .....	25
--	----

**G**

General Purpose Headrest.....	17
-------------------------------	----

**H**

Horseshoe Conversion Adaptor .....	34
Horseshoe Headrest Gel Pads.....	18

**I**

Infinity Adult Horseshoe .....	19
Infinity Coupler .....	18
Infinity General Purpose Headrest .....	19
Infinity Pediatric Horseshoe.....	19
Infinity Skull Clamp System .....	12, 20
Infinity Support System .....	18
Infinity XR2 Base Units .....	22
Infinity XR2 Skull Clamp.....	23
Infinity XR2 Tri-Star Swivel Adaptor .....	25
Instrument Wall Storage Unit.....	33
Integra Brain retractor system .....	29

**L**

Link Arm Extensions.....	25
--------------------------	----

**M**

MAYFIELD®2 Skull Clamp .....	7
MAYFIELD®2 Standard Base Unit .....	7
MAYFIELD®2 TriStar Swivel Adaptor .....	7
Modified Skull Clamp .....	13
Modified Swivel Adaptor .....	10
Modified TriStar Swivel Adaptor.....	11

**N**

NeuroGen Adaptor .....	32
------------------------	----

**P**

Papadopoulos Posterior Cervical Spine (PCS) Support.....	17
Pediatric Disposable Skull Pins.....	15
Pediatric Horseshoe Headrest .....	17
Pediatric Radiolucent Horseshoe Headrest .....	24
Pediatric Reusable Skull Pins .....	14

**R**

Radiolucent Spine Table Adaptor .....	23
Removable Child Rocker Arm .....	25
Removable Rocker Arm.....	23

**S**

Single Pin Accessory .....	21
Spine Table Adaptor Metal.....	9
Standard Adult Rocker Arm.....	21
Swivel Adaptor .....	10

**T**

Torque Screw.....	20
Triad Horseshoe Conversion Adaptor with Knobs .....	34
Triad Rocker Arm.....	21
Triad Skull Clamp .....	12
TriStar Swivel Adaptor.....	11

**U**

Ultra 360 Patient Positioning System.....	8
Ultra Base Unit .....	8
Universal Side Rail Fitting.....	33

**#**

A1008 .....	17
A1011 .....	16
A1012 .....	16
A1015 .....	32
A1018 .....	10
A1023.....	33
A1040 .....	26
A1047 .....	14
A1048.....	14
A1051 .....	17
A1059.....	13
A1060 .....	33
A1064.....	10, 16



A1067 .....	26, 34	S41C1444 .....	18
A1072 .....	15	S41C1445 .....	18
A1073 .....	17	S438A1011 .....	26
A1083 .....	15	S438A1012 .....	26
A1084 .....	15	S438A1024 .....	26
A1096 .....	29	S438A1037 .....	26, 28
A1108 .....	12	S438A1096 .....	26
A1109 .....	34	S438A1140 .....	26, 28, 30
A1110 .....	34	S438A1188 .....	26
A1112 .....	18	S438B1010 .....	26
A1113 .....	32	S438B1178 .....	26
A1114 .....	12, 20	S440C1011 .....	18
A1115 .....	10	S440C1012 .....	18
A1116 .....	11	S443A1000 .....	28
A1118 .....	33	S443A1004 .....	28
A1119 .....	15	S443A1005 .....	28
A1120 .....	15	S443A1060 .....	28
A1121 .....	14	S443A1070A .....	28
A1122 .....	14	S443A1070B .....	28
A2000 .....	13	S443A1070C .....	28
A2008 .....	11	S443B1052 .....	28
A2009 .....	8	417A1000 .....	29
A2010 .....	24	417A1001 .....	29
A2011 .....	24	417A1002 .....	29
A2012 .....	27	417A1003 .....	29
A2020 .....	15	417A1004 .....	29
A2079 .....	22	417A1005 .....	29, 30
A2079E .....	22	417A1006 .....	29, 30
A2101 .....	8, 16, 18	417A1007 .....	29, 30
A2111 .....	25	417A1008 .....	29, 30
A2114 .....	22, 23, 29	417A1009 .....	29, 30
A2600M .....	9	417A1010 .....	29
A2600R .....	23	437A2224 .....	25
A3008 .....	7	437A2225 .....	25
A3018 .....	7	438A1077 A,B,C,D,X .....	26, 28, 30
A3059 .....	7	438A1082 A,B,C .....	26, 28, 30
A3101 .....	7	438A1083 A,B,C .....	26, 28, 30
S419A1030 .....	18, 19	438A1151 A,B,C,D .....	26, 28, 31
S419A1031 .....	18, 19	438A1152 A,B,C,D .....	26, 28, 31
S419A1048 .....	18	438A1154 B,C,D,E .....	26, 28, 30
S419A1050 .....	18, 19	438A1155 A,B,C,D .....	26, 28, 31
S419A1060 .....	18	438A1157 A,B,C,D .....	26, 28, 31
S419A1207 .....	20, 21	438A1200A .....	26, 28, 31
S419A1208 .....	20	438A1200B .....	26, 28, 31
S419A1209 .....	20	439A1091 .....	25
S419A1250 .....	20	439A1092 .....	25
S419B1010 .....	18	439A1093 .....	25
S419B1204 .....	20, 21	439A1094 .....	23
S419B1205 .....	20, 21		
S419B1206 .....	20, 21		
S41A1482 .....	20		
S41A1614 .....	8		
S41B1615 .....	8		







Availability of these products might vary from a given country or region to another, as a result of specific local regulatory approval or clearance requirements for sale in such country or region.

Consult product labels and inserts for any indication, contraindications, hazards, warnings, precautions, and instructions for use.

Non contractual document. The manufacturer reserves the right, without prior notice, to modify the products in order to improve their quality.

Warning: Applicable laws restrict these products to sale by or on the order of a physician.

Products mentioned in this document are CE class I, IIa devices. Please contact Integra customer service should you need any additional information on devices classification. All the medical devices mentioned on this document are CE marked according to European council directive 93/42/EEC on medical devices and its relatives, unless specifically identified as "NOT CE MARKED".

#### Sales & Marketing EMEA

Integra LifeSciences Services (France) SAS  
Immeuble Séquoia 2 ■ 97 allée Alexandre Borodine  
Parc technologique de la Porte des Alpes  
69800 Saint Priest ■ FRANCE  
Phone: +33 (0)4 37 47 59 00 ■ Fax: +33 (0)4 37 47 59 99  
integralife.eu

#### Integra Contact - Questions, Information & Product Ordering

International: +33 (0)437 47 59 50 ■ +33 (0)437 47 59 25 (Fax) ■ csemea@integralife.com  
Austria: +43 (0)720816067 ■ +43 (0)19287201 (Fax) ■ custsvcaustria@integralife.com  
Belgium & Luxembourg: +32 (0)2 257 4130 ■ +32 (0)2 253 2466 (Fax) ■ custsvcbenelux@integralife.com  
France: +33 (0) 437 47 59 10 ■ +33 (0) 437 47 59 29 (Fax) ■ custservfrance@integralife.com  
Germany: +49 (0)2102 5535 6200 ■ +49 (0)2102 5536 636 (Fax) ■ custsvcgermany@integralife.com  
Ireland: +353 1800 901567 ■ +353 1822 5952 (Fax) ■ custsvcire@integralife.com  
Italy: +39 (0)2 577 89 21 ■ +39 (0)2 575 113 71 (Fax) ■ custsvcitaly@integralife.com  
Netherlands: +31 (0)852083167 ■ +31 (0)207093627 (Fax) ■ custsvcnetherlands@integralife.com  
Switzerland: +41 (0)2 27 21 23 00 ■ +41 (0)2 27 21 23 99 (Fax) ■ custsvcsuisse@integralife.com  
United Kingdom: +44 (0)1264 312 725 ■ +44 (0)1264 312 821 (Fax) ■ custsvcs.uk@integralife.com



Manufacturer:

 Integra LifeSciences Corporation  
4900 Charlemer Drive ■ Bldg. A  
Cincinnati ■ Ohio 45227 ■ USA



Integra LifeSciences Services (France)  
Immeuble Séquoia 2, 97 allée Alexandre Borodine  
Parc technologique de la Porte des Alpes  
69800 Saint Priest ■ France